

# LOUVRE

Elegante e importante, senza rinunciare alla stabilità.

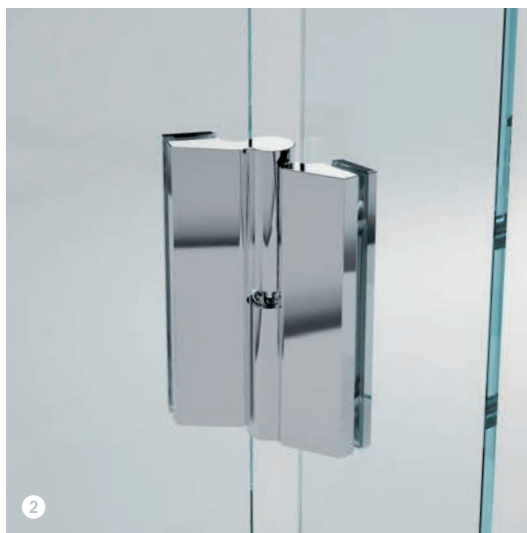

- 1 Nuova finitura vetro fumé. 2 Cerniere cromate con sollevamento.  
3 Barra di sostegno a muro.

## TRATTAMENTI







**TRATTAMENTO ANTIGOCCIA**  
Cristalli sempre brillanti, facili da pulire.  
Impedisce la formazione del calcare e dei batteri.  
**Solo su vetri trasparenti.**

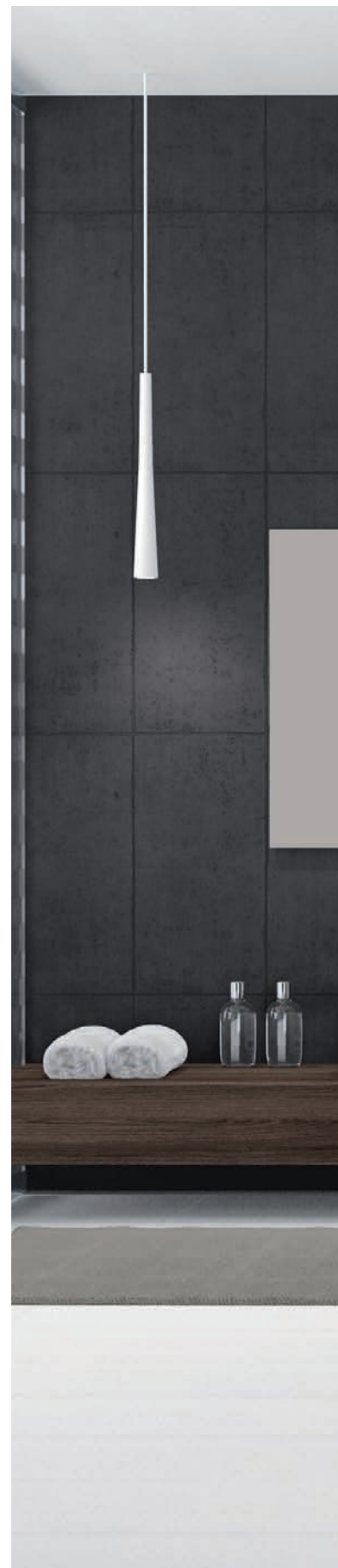

**FINITURA CROMO PVD**  
Ciclo di produzione integrata a zero emissioni, 100% ecologico. Anticalcare, resistente all'azione batterica, ecologica brillantezza resistente nel tempo.



# LOUVRE G







PORTA DOCCIA, APERTURA 1 ANTA BATTENTE E 1 FISSA IN LINEA  
in nicchia

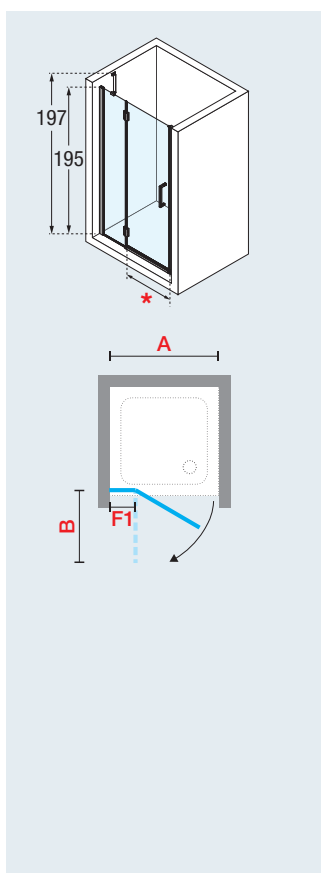

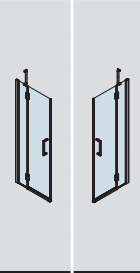
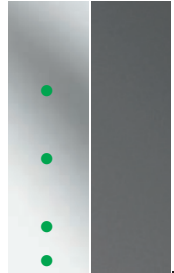
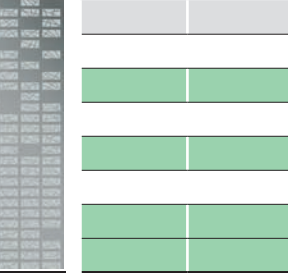
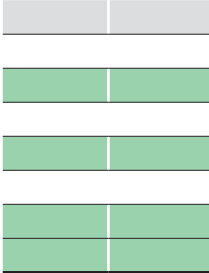
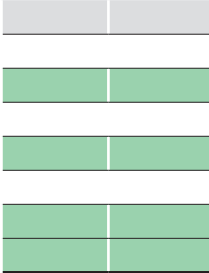
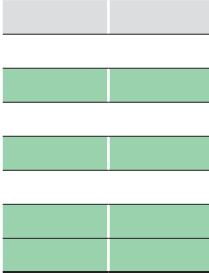
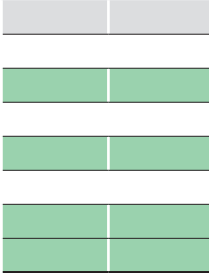

Misure				Codice	Sinistra	Destra	Scelta Vetro			Scelta Profilo / Prezzo	
Misura effettiva d'ingombro	Fisso frontale	Entrata	Ingombro anta esterno		S-	D-	1	54	58	B	K
<b>A</b>	<b>F1</b>	<b>*</b>	<b>B</b>				Trasparente	Fumè	Serigrafia Louvre	Silver	Cromo
68 ↔ 71	15	50	51	<b>LOUVR G 70 L</b>							
73 ↔ 76	20	50	51	<b>LOUVR G 75 L</b>							
78 ↔ 81	25	50	51	<b>LOUVR G 80 L</b>							
83 ↔ 86	15	65	66	<b>LOUVR G 85 L</b>							
88 ↔ 91	20	65	66	<b>LOUVR G 90 L</b>							
93 ↔ 96	25	65	66	<b>LOUVR G 95 L</b>							
98 ↔ 101	30	65	66	<b>LOUVR G 100 L</b>							
108 ↔ 111	40	65	66	<b>LOUVR G 110 L</b>							
<b>H 170 ↓ 220 L 68 ↔ 121 SPECIAL</b>				<b>LOUVR G SP</b>	-	-					

ESEMPIO COMPILAZIONE CODICE:

LOUVRG70LS-1B

=

LOUVRG70L

+

S-

+

1

+

B

• Disponibilità indicativa deposito centrale 7gg.

# LOUVRE G+F



195 cm



6 mm



3 cm



p. 93

BOX DOCCIA AD ANGOLO, APERTURA 1 ANTA BATTENTE E 1 FISSO IN LINEA CON PANNELLO FISSO LATERALE



FISSO



PORTA

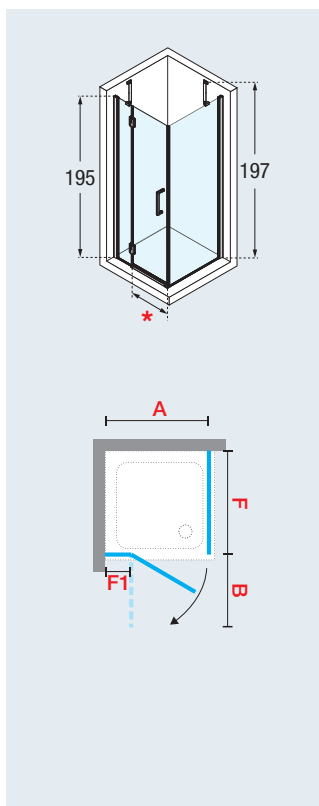

Misure				Codice	Sinistra	Destra	Scelta Vetro			Scelta Profilo Prezzo	
Misura effettiva d'ingombro	Fisso frontale	Entrata	Ingombro anta esterno		S-	D-	1	54	58	B	K

### PORTA

A	F1	*	B	Codice
66,5 ↔ 69,5	15	50	51	<b>LOUVR GF 70 L</b>
71,5 ↔ 74,5	20	50	51	<b>LOUVR GF 75 L</b>
76,5 ↔ 79,5	25	50	51	<b>LOUVR GF 80 L</b>
81,5 ↔ 84,5	15	65	66	<b>LOUVR GF 85 L</b>
86,5 ↔ 89,5	20	65	66	<b>LOUVR GF 90 L</b>
91,5 ↔ 94,5	25	65	66	<b>LOUVR GF 95 L</b>
96,5 ↔ 99,5	30	65	66	<b>LOUVR GF 100 L</b>
106,5 ↔ 109,5	40	65	66	<b>LOUVR GF 110 L</b>

H 170 ↓ 220 L 66,5 ↔ 119,5 SPECIAL **LOUVR GF SP**

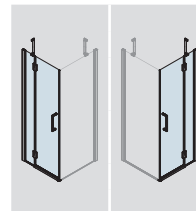

Trasparente	Fumè	Serigrafia Louvre	Silver	Cromo
●				
●				
●				
●				

### PARETE FISSA - REVERSIBILE

F	Codice
66,5 ↔ 69,5	<b>LOUVR F 70-</b>
71,5 ↔ 74,5	<b>LOUVR F 75-</b>
76,5 ↔ 79,5	<b>LOUVR F 80-</b>
81,5 ↔ 84,5	<b>LOUVR F 85-</b>
86,5 ↔ 89,5	<b>LOUVR F 90-</b>
91,5 ↔ 94,5	<b>LOUVR F 95-</b>
96,5 ↔ 99,5	<b>LOUVR F 100-</b>
106,5 ↔ 109,5	<b>LOUVR F 110-</b>
116,5 ↔ 119,5	<b>LOUVR F 120-</b>

H 170 ↓ 220 L 21 ↔ 119,5 SPECIAL **LOUVR F SP**

Trasparente	Fumè	Serigrafia Louvre	Silver	Cromo
●				
●				
●				

● Disponibilità indicativa deposito centrale 7gg.

ESEMPIO COMPILAZIONE CODICE:

LOUVRGF70LS-1B = LOUVRGF70L + S- + 1 + B

## DATI TECNICI

### VETRO TEMPRATO 6 mm

(European standards UNI EN 14428)

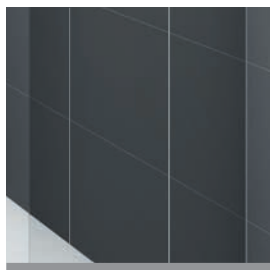

trasparente  
COD. 1



fumé  
COD. 54

### SERIGRAFIA



louvre  
COD. 58

### MANIGLIA



maniglia in metallo  
cromato.  
**interasse 256mm**

Per informazioni altre  
maniglie vedi pag. 318

### FINITURA PROFILI



silver  
COD. B



cromo  
COD. K

### MISURE DI INGOMBRO PROFILI DI FISSAGGIO

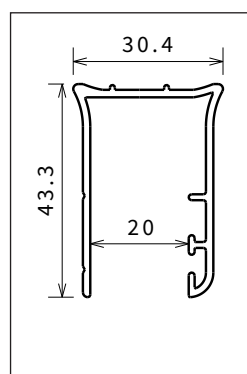

a muro

COD. P02DIAS-T-B  
P02DIAS-T-K

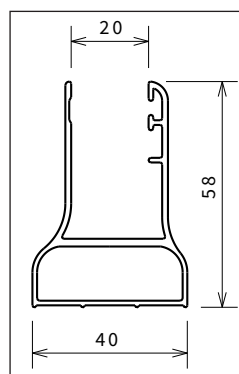

compensativi

COD. P04DIAS-T-B  
P04DIAS-T-K

Per ulteriori  
informazioni  
sui profili,  
vedi pag. 332

### OPTIONAL



#### Barra di sostegno ad angolo

Misure	Codice	Prezzo
15 cm	<b>R80LOU150-K</b>	
25 cm	<b>R80LOU250-K</b>	
35 cm	<b>R80LOU350-K</b>	
45 cm	<b>R80LOU450-K</b>	

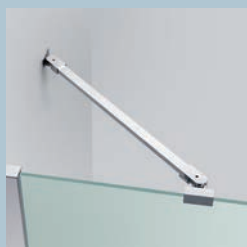

#### Kit barra orientabile

- 1 barra orientabile da 100 cm (accorciabile)
- 1 attacco a muro
- 1 morsetto di fissaggio al vetro

Finitura	Codice	Prezzo
Bianco	<b>R80KUOR100-D</b>	
Silver	<b>R80KUOR100-B</b>	
Cromo	<b>R80KUOR100-K</b>	

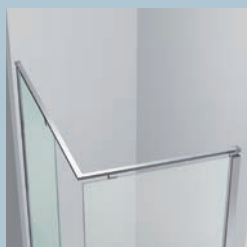

#### Sistema di fissaggio EVO

- 1 barra frontale da 180 cm
- 1 barra laterale da 120 cm
- 2 morsetti di fissaggio
- 1 angolare di unione

Finitura	Codice	Prezzo
Silver	<b>KUADHSF-B</b>	
Cromo	<b>KUADHSF-K</b>	

### COME RILEVARE LE MISURE

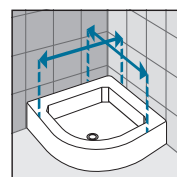
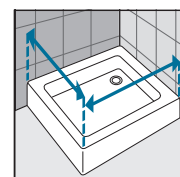

Rilevare le misure da muro a bordo esterno del piatto doccia. Le misure devono essere rilevate sulla parete finita, a rivestimenti posati, secondo gli schemi riportati.

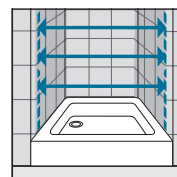

Rilevare le misure da muro a muro, in basso, in alto, al centro e utilizzare quella di valore inferiore. Le misure devono essere rilevate sulla parete finita, a rivestimenti posati, secondo gli schemi riportati.