

 -50%

7

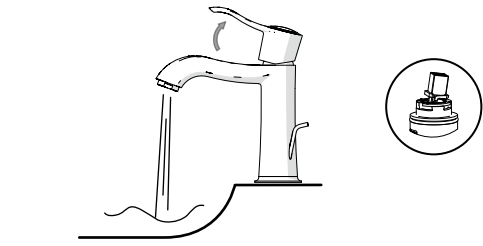

ON 50%

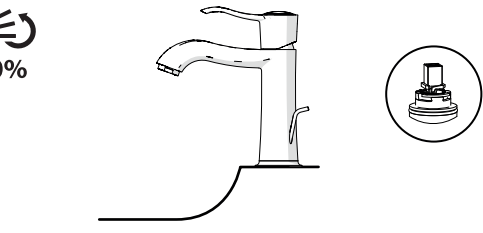
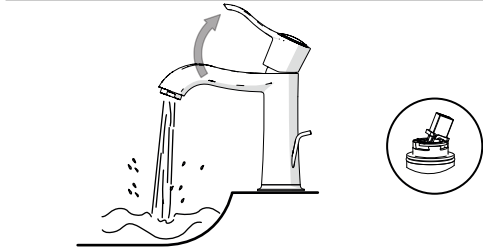

ON 100%

9

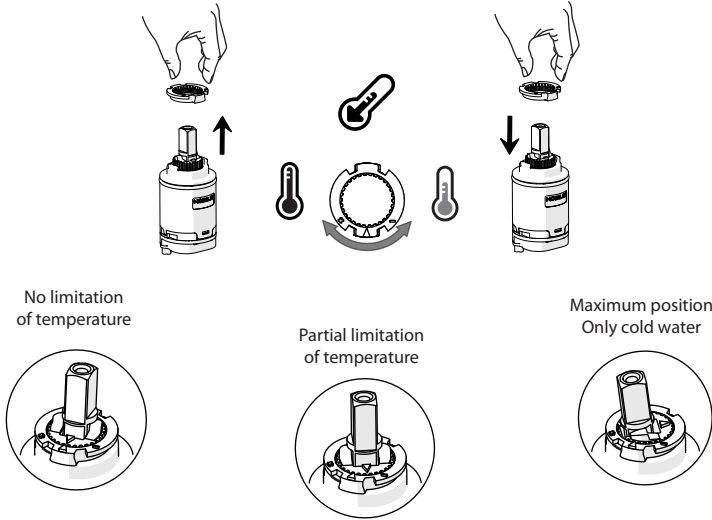

No limitation of temperature

Partial limitation of temperature

Maximum position Only cold water

NOBILIS
The Best Technology for Water

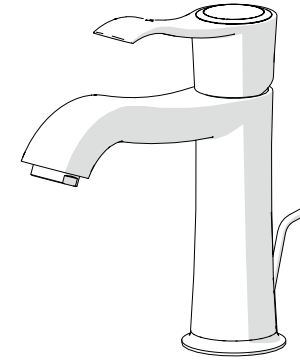

SI98118/1



www.grupponobili.it

IISTR98118/1#---STD

REV1.05/2013

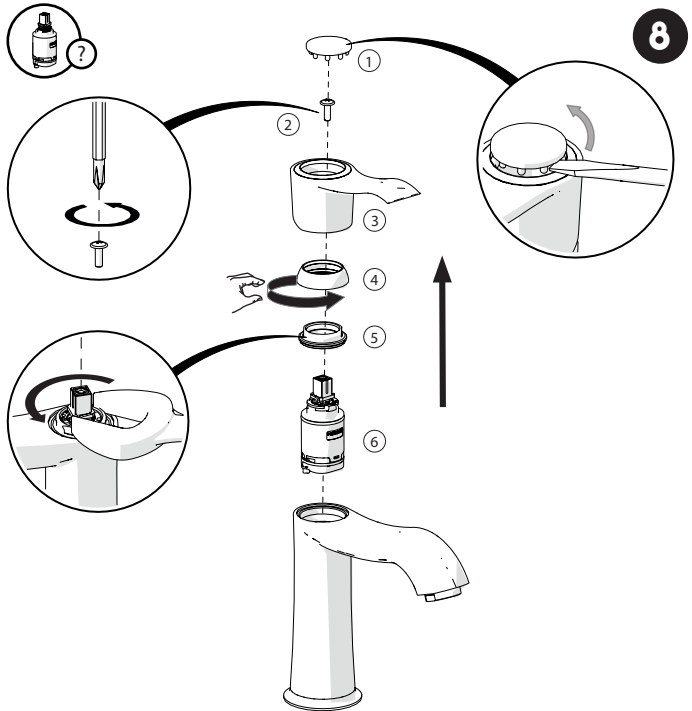

8

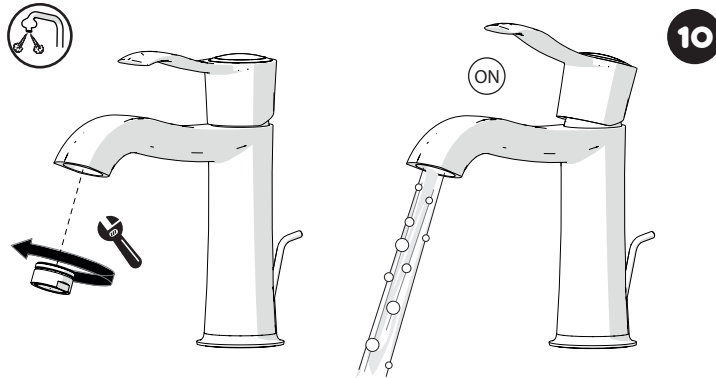

10

 **CLEANING**

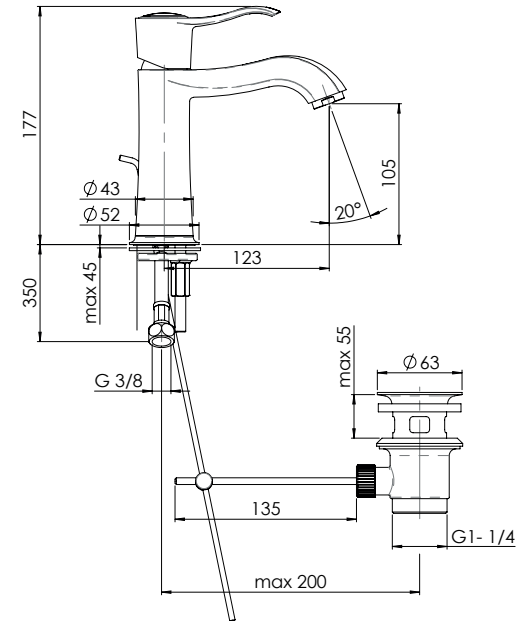
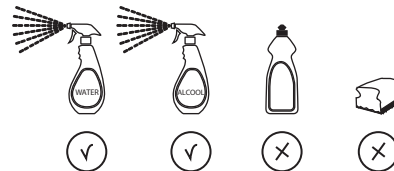

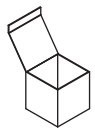

+



Not included / Non incluso / Non inclus / Nie zawarty / No incluido / Não incluido



C

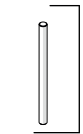
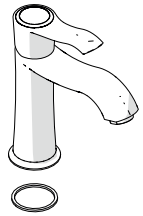

A



D

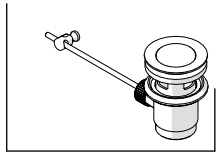

E

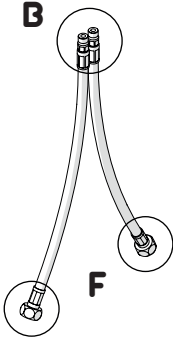

B

1

2

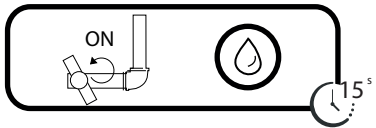

ON

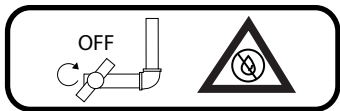
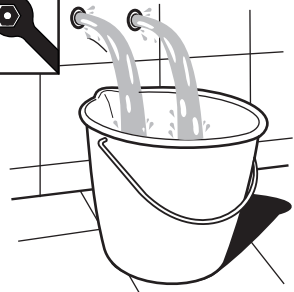

OFF

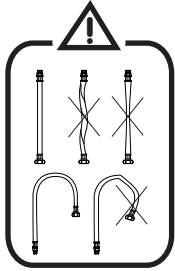

D

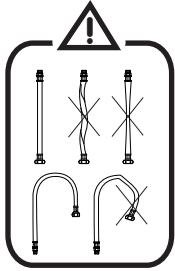

D

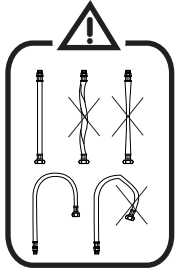

D

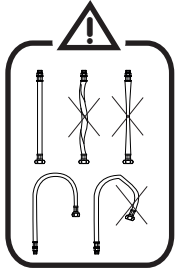

D

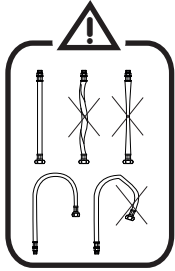

D

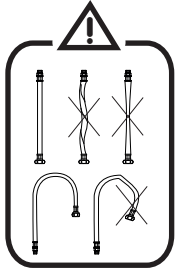

D

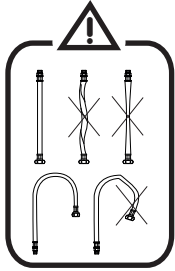

D

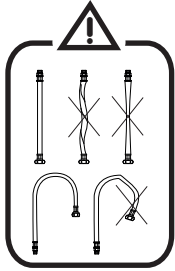

D

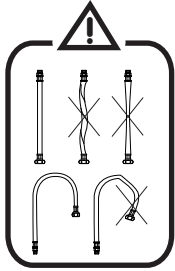

D

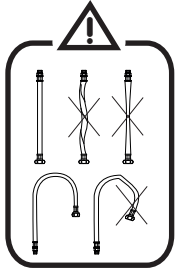

D

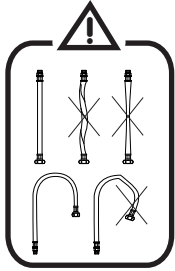

D

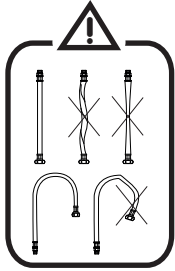

D

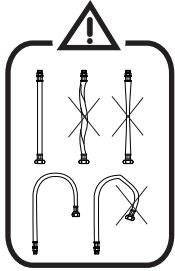

D

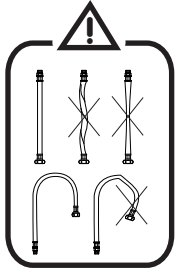

D

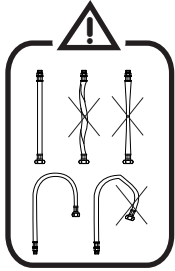

D

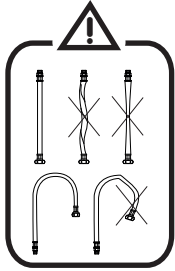

D

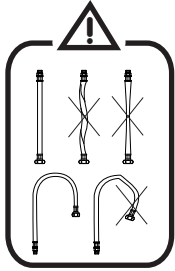

D

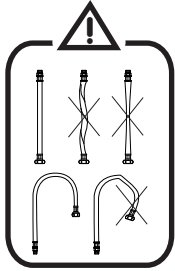

D

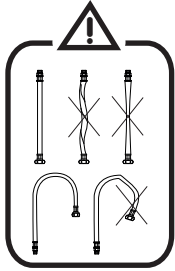

D

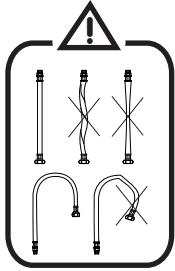

D

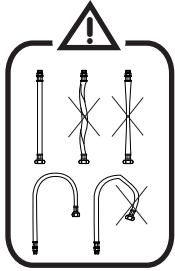

D

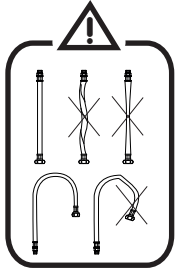

D

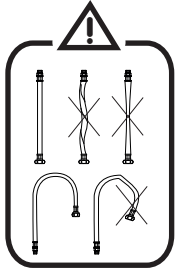

D

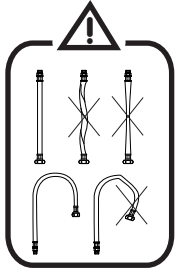

D

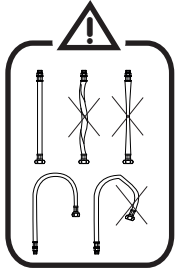

D

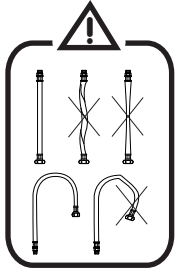

D

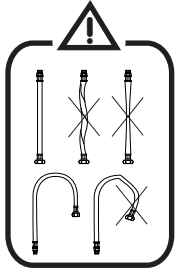

D

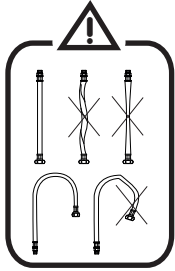

D

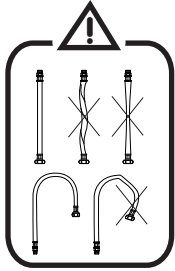

D

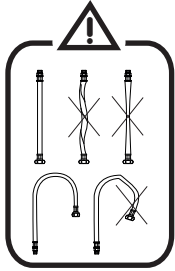

D

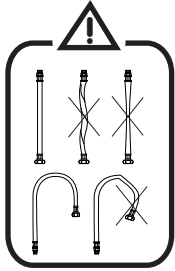

D

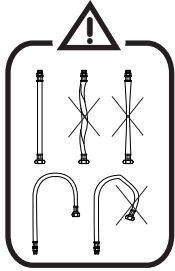

D

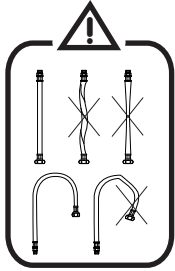

D

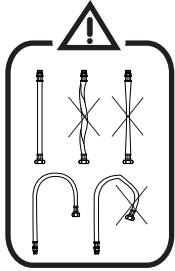

D

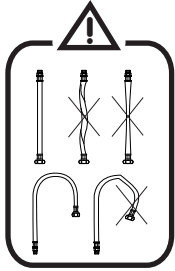

D

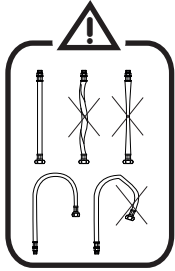

D

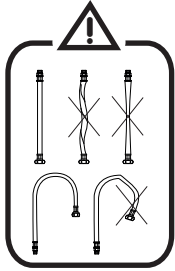

D

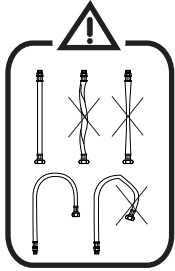

D

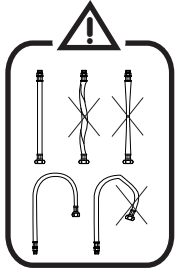

D

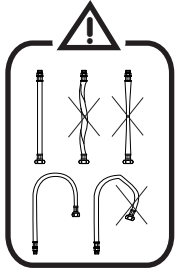

D

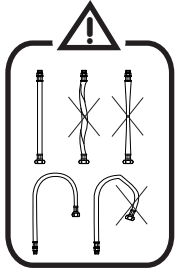

D

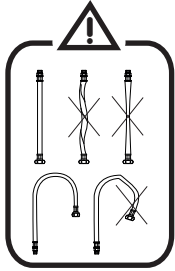

D

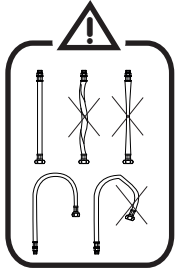

D

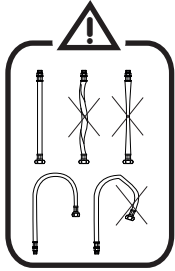

D

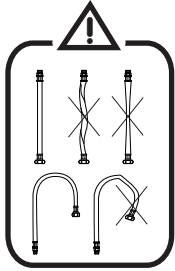

D

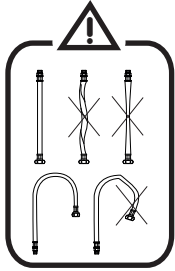

D

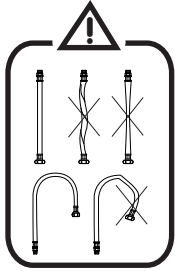

D

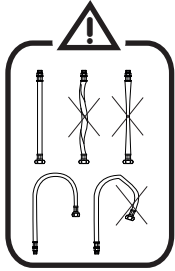

D

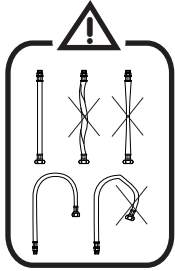

D

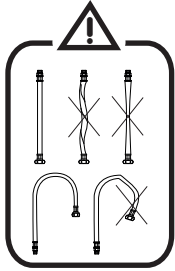

D

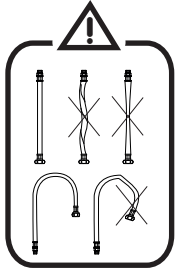

D

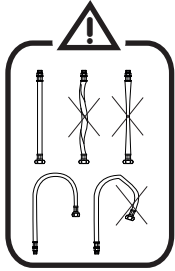

D

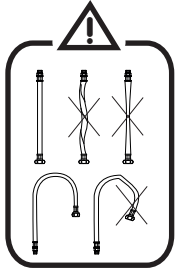

D

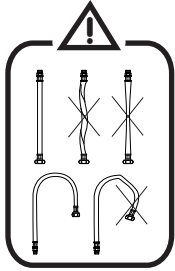

D

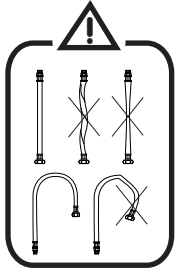

D

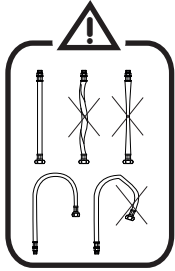

D

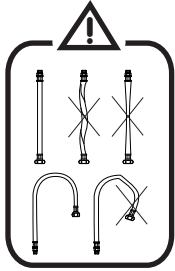

D

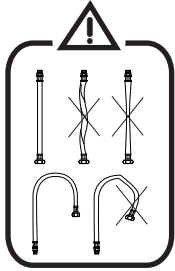

D

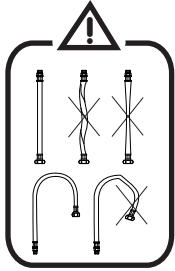

D

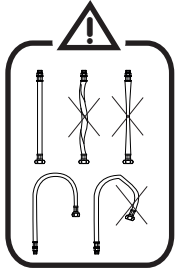

D

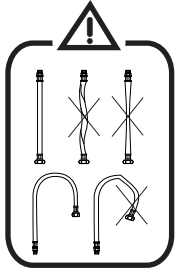

D

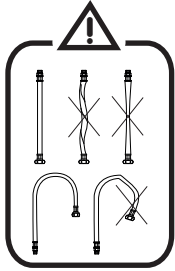

D

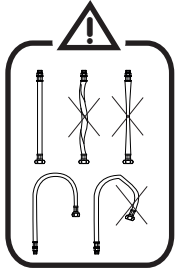

D

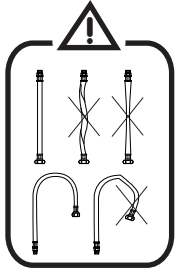

D

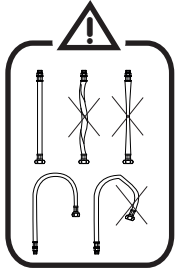

D

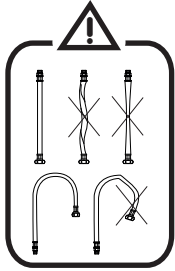

D

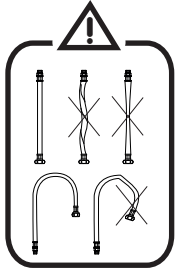

D

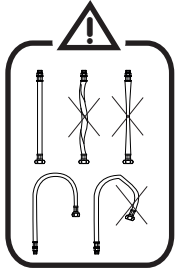

D

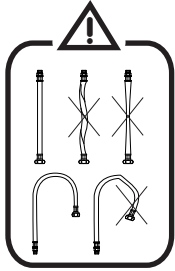

D

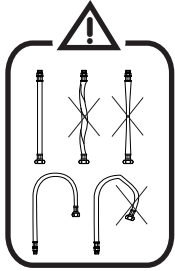

D

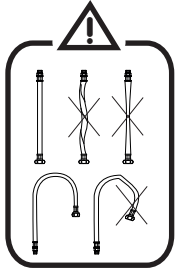

D

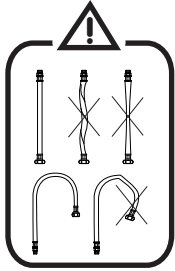

D

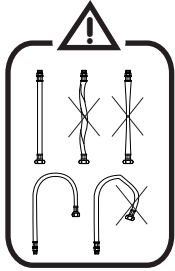

D

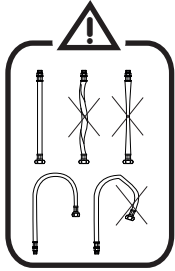

D

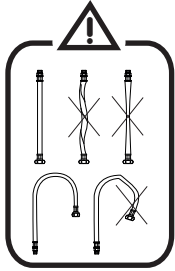

D

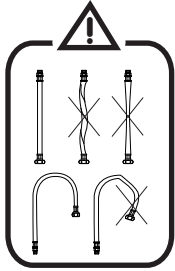

D

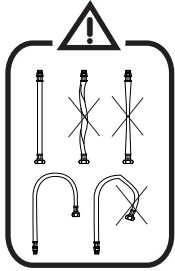

D

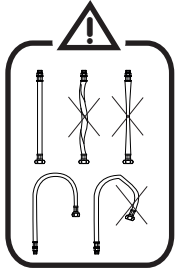

D

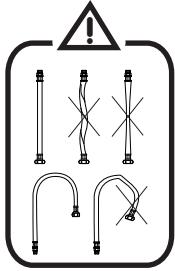

D

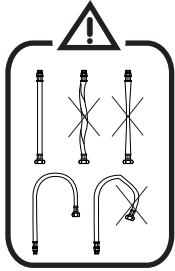

D

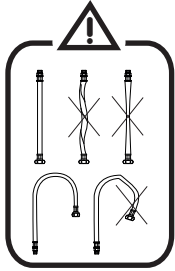

D

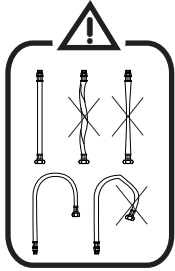

D

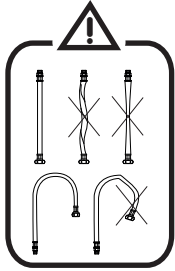

D

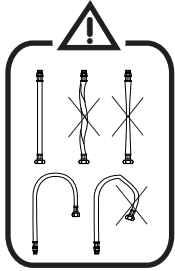

D

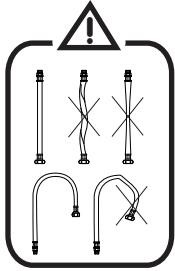

D

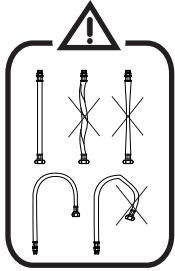

D

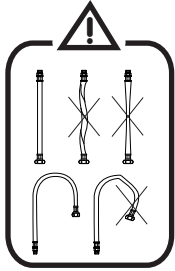

D

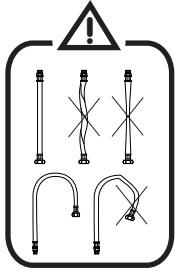

D

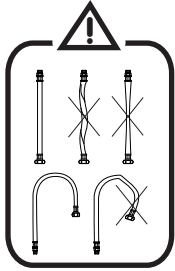

D

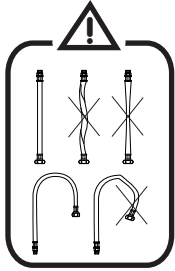

D

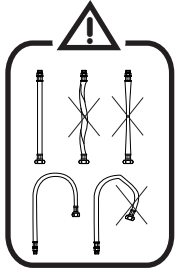

D

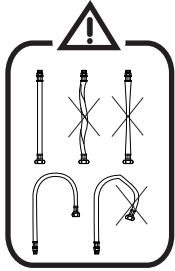

D

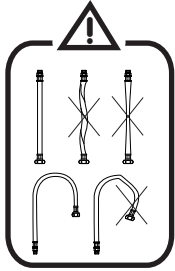

D

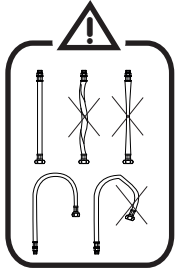

D

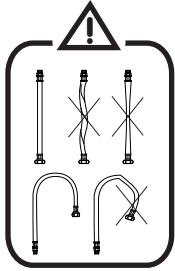

D

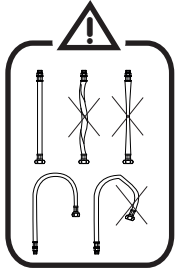

D

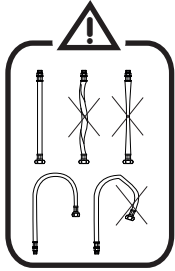

D

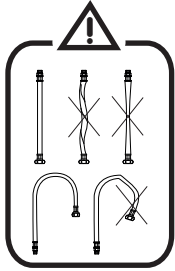

D

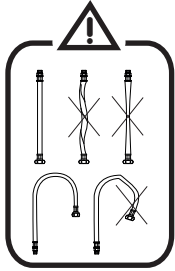

D

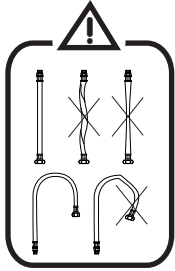

D

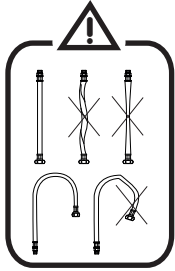

D

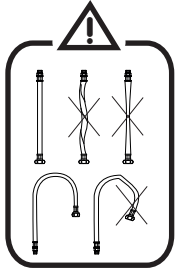

D

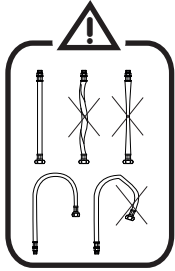

D

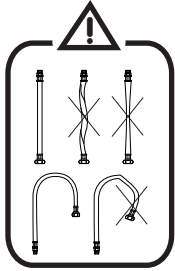

D

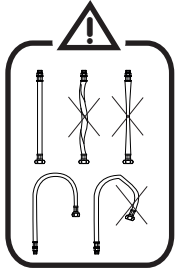

D

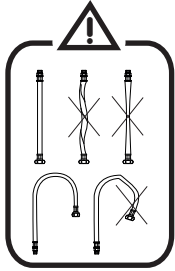

D

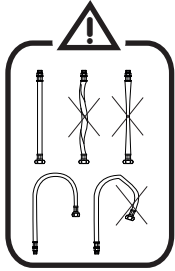

D

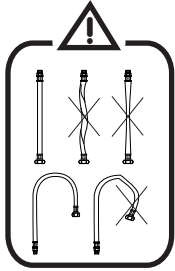

D

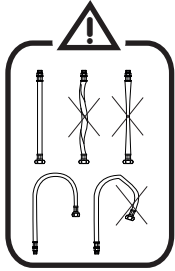

D

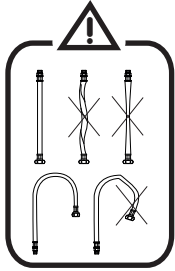

D

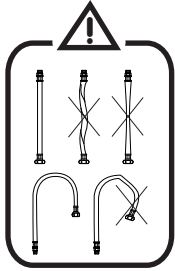

D

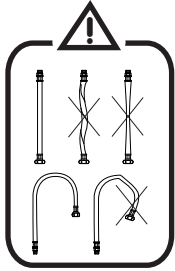

D

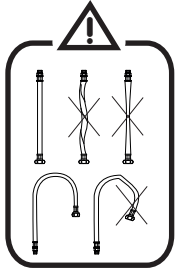

D

